

ASSEMBLY & INSTALLATION INSTRUCTIONS

500821-30



INTRODUCTION

To ensure that your installation proceeds smoothly, read these instructions carefully before you begin. Also, review the recommended tools and materials section. Carefully unpack and examine your new plumbing fixture.

ALL INSTALLATION PROCEDURES MUST COMPLY IN STRICT ACCORDANCE WITH APPLICABLE LOCAL PLUMBING AND BUILDING CODES

Tools and materials Required

Most of the procedures require the use of available hand tools and plumbing supplies. It is essential that the tools and materials be on hand before work is begun.



Adjustable wrench



Saber Saw

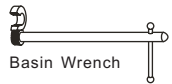

Basin Wrench

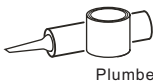

Plumbers' Putty or Caulking

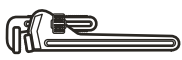

Pipe Wrench



Putty Knife



Tape Measure



Tubing Cutter



Hacksaw



Regular Screwdriver



Hammer



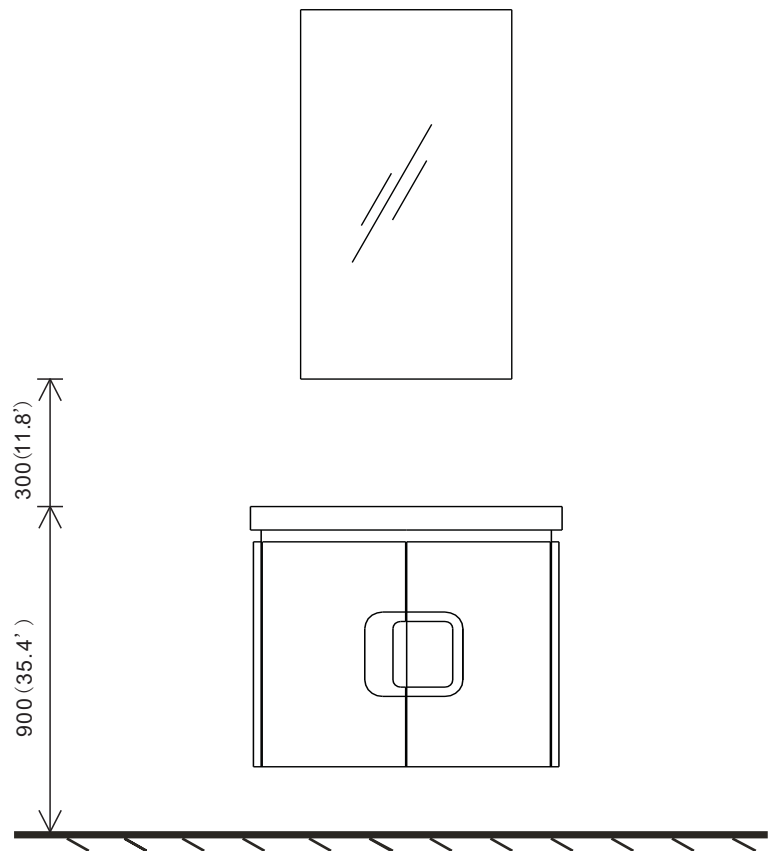

Level

Roughing-in Dimensions

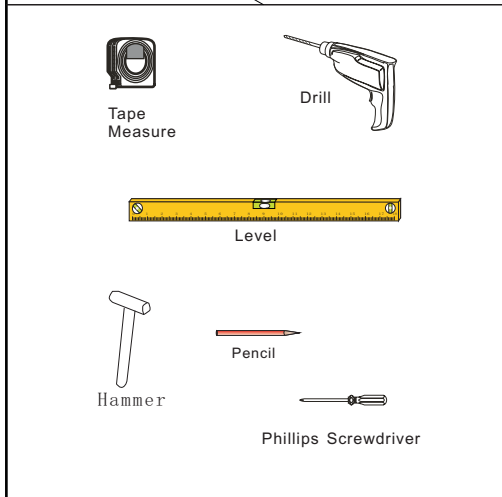
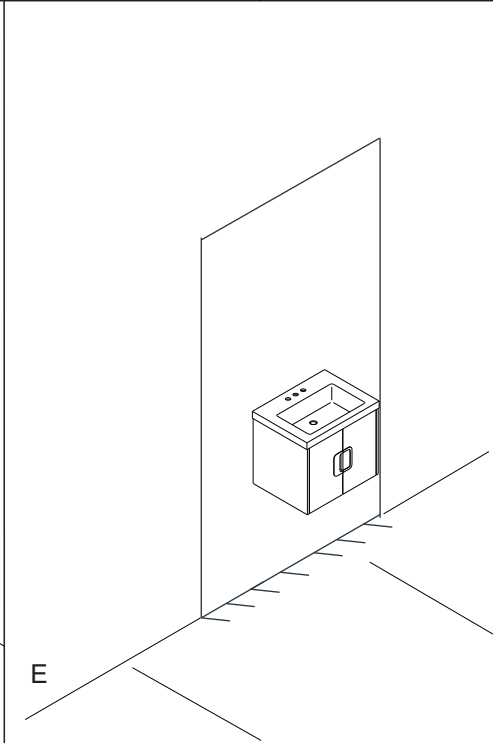
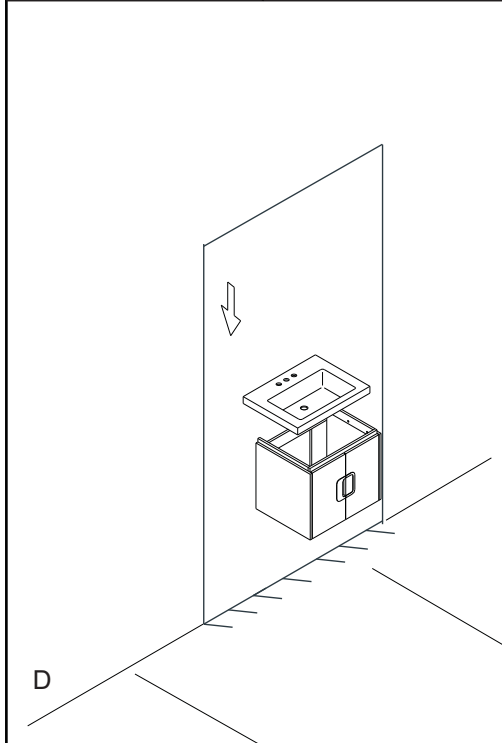
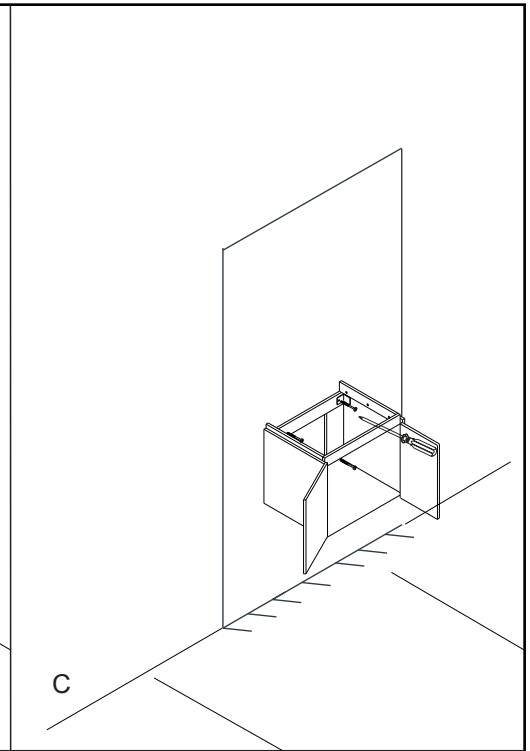
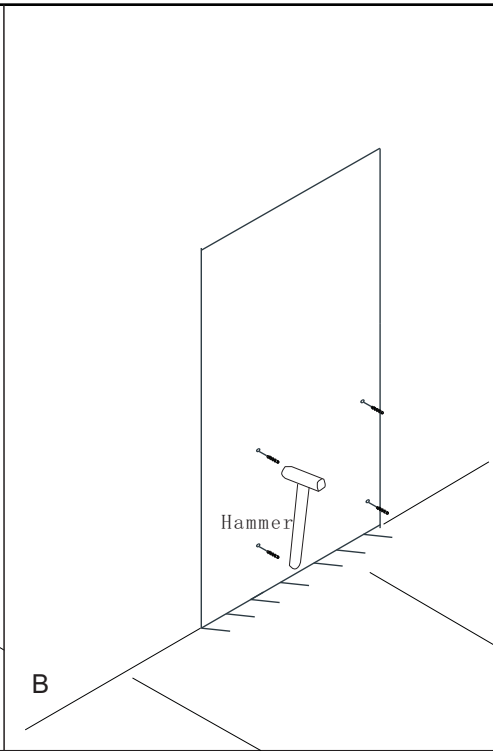
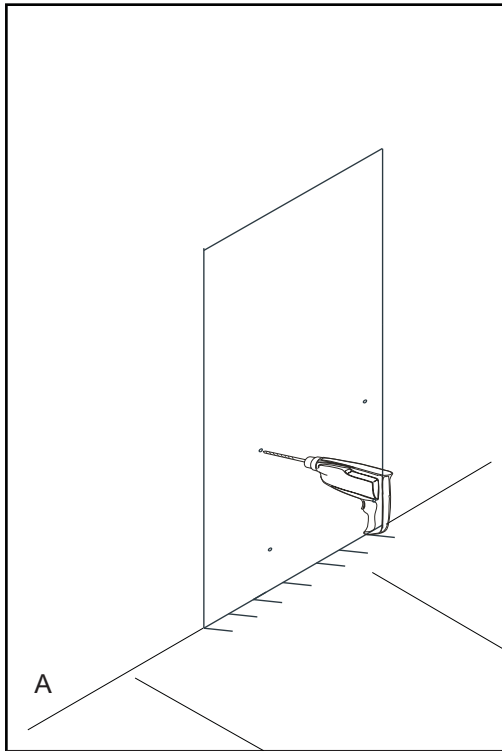

*Dimensions shown for location of supplies and "P" trap are suggested.



Accessory list	Code	①	②
	Component		
	Name	Expended partides	screw
	QTY	4	4